

jura[®]



X10 (EA/SA/INTA)
Instructions for Use



Original instructions for use
Before using the machine read the instructions for use.

JURA Type 777

Your X10

1 Control elements	4
2 For your safety	6
Comply with the instructions for use	6
Proper use	6
User limitations	6
Use by children	7
What to do in the event of damage	7
Preventing damage	8
Danger of electric shock	9
Danger of burns, scalding and injury	9
3 Preparing and using for the first time	10
Setting up the machine	10
Filling the bean container	10
Determining the water hardness	10
First-time use	11
Managing your X10 – the JURA Cockpit	12
Connecting milk	12
4 Preparation	13
Preparation with preselection (Speciality Selection)	14
Espresso and coffee	14
Cold Brew	14
Latte macchiato, cappuccino and other speciality coffees with milk	15
Americano and lungo	15
Hot water	16
Adjusting the grinder	16
Adjusting the product settings	16
5 Daily operation	17
Switching the machine on and off	17
Filling the water tank	17
Maintenance actions	18
6 Machine settings	19

7 Maintenance	20
Rinsing the machine	20
Automatic milk system rinsing	20
Inserting/changing the filter	20
Cleaning the milk system	21
Dismantling and rinsing the dual spout	22
Cleaning the machine	23
Descaling the machine	24
Descaling the water tank	26
Cleaning the bean container	26
8 Display messages	27
9 Troubleshooting	28
10 Transport and environmentally friendly disposal	30
Transport / Emptying the system	30
Disposal	30
11 Technical data	31
12 Index	32
13 JURA contact details / Legal information	36

1 Control elements

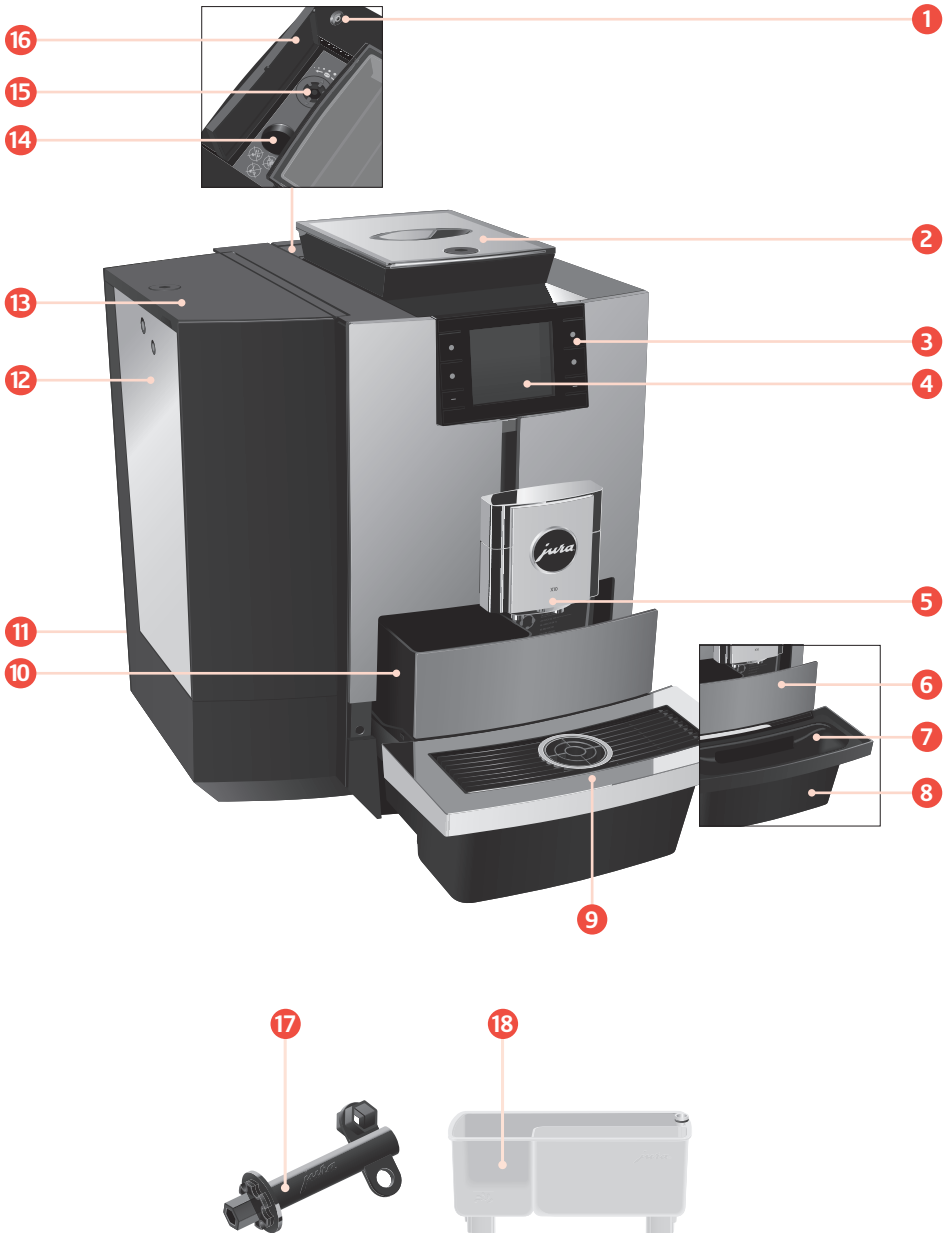

- 1 On/Off button 
- 2 Bean container with aroma preservation cover (lockable)
- 3 Multi-function buttons (button function depends on what is shown in the display)
- 4 Display
- 5 Height-adjustable dual spout
- 6 Insert with panel
- 7 Insert for drip tray
- 8 Drip tray
- 9 Cup grille
- 10 Coffee grounds container
- 11 Mains cable (permanently connected or plug-in) (back of the machine)
- 12 Water tank
- 13 Water tank cover (lockable)
- 14 Filler funnel for cleaning tablet
- 15 Grinder adjustment wheel
- 16 Cover
- 17 Spanner for aroma preservation cover, water tank cover and grinder adjustment wheel
- 18 Container for milk system cleaning

Service socket for optionally available JURA Wi-Fi Connect / Payment Connect / MDB Connect

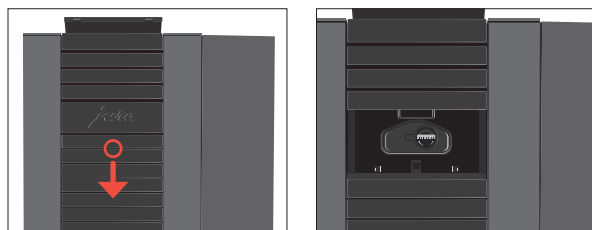



2 For your safety

Comply with the instructions for use

Before using the machine, read these instructions for use thoroughly and completely and comply with the instructions they contain. Keep these instructions for use close to the machine and pass them on to the next user.

Failure to observe the instructions for use may result in serious injuries or damage to property. Safety information is therefore indicated as follows:

 WARNING	Indicates circumstances that may result in serious injuries or death.
 CAUTION	Indicates circumstances that may result in minor injuries.
CAUTION	Indicates circumstances that may result in damage to property.

Proper use

This machine is intended for use by specialist or trained staff in businesses, light industry and agricultural facilities or for commercial use by non-professionals. It should only be used for coffee preparation and to heat milk and water. Use for any other purpose will be deemed improper.

User limitations

People, including children, who

- do not have the physical, sensory or mental capabilities to use the machine safely or
- are inexperienced or lack knowledge

must be supervised by a responsible person when using it, or must be instructed in how to use it correctly.

When using the CLARIS Pro Smart+ filter cartridge or a JURA Wi-Fi Connect / Payment Connect / MDB Connect, wireless connections are established. Specific details on the frequency band used and the maximum transmission power can be found in the 'Technical data' section.

Use by children

Children must be able to recognise and understand the potential dangers arising from incorrect use:

- Keep **children under the age of 8** away from the machine, or supervise them constantly.
- **Children aged 8 and over** may only operate the machine without supervision if they have been instructed in how to use it safely.
- Children may not clean or service the machine unless supervised by a responsible person.
- Do not allow children to play with the machine.

What to do in the event of damage

Never use a damaged machine or mains cable. This could result in fatal electric shock.

- In the event of signs of damage, disconnect the machine from the mains. To do this, first switch the X10 off with the On/Off button . Only then should you remove the mains plug from the power socket.
- Replace a damaged **plug-in mains cable** with an original JURA mains cable. Unsuitable mains cables may result in consequential damage.
- Only permit authorised JURA service centres to carry out **repairs to the machine** and the **permanently connected mains cable**. Unsuitable repairs may result in consequential damage.

Preventing damage

To avoid damage to the machine and the mains cable:

- Do not use the X10 and the mains cable near hot surfaces.
- Do not allow the mains cable to rub against sharp edges and ensure that it does not become trapped.
- Never allow the mains cable to loosely hang down. The mains cable could pose a tripping hazard or become damaged.
- Protect the X10 from weather and direct sunlight.
- Only connect the X10 to a mains voltage corresponding to that stated on the rating plate. The rating plate is located on the underside.
- Connect the X10 directly to a domestic power socket. Using multi-socket adapters or extension cords may cause overheating.
- Do not use alkaline or alcohol-based cleaning agents; only use mild cleaning agents and a soft cloth.
- Do not use any coffee beans treated with additives or caramelised coffee beans.
- Only fill the water tank with fresh, cold, non-carbonated water.
- Switch the machine off with the On/Off button  if you are going to be absent for a longer period of time and remove the mains plug from the power socket.
- Only use original JURA maintenance products. Use of products that are not explicitly recommended by JURA could damage your X10.

Danger of electric shock

Water conducts electricity. Do not bring water and electricity into contact with one another:

- Never touch the mains plug with wet hands.
- Do not immerse the X10 and/or mains cable in water.
- Do not put the X10 or any individual parts in the dishwasher.
- Before cleaning, switch the X10 off with the On/Off button . Always wipe the X10 with a damp cloth rather than a wet one, and protect it from prolonged exposure to water splash. The X10 must not be cleaned with a jet of water.
- The X10 is not suitable for installation on a surface where a jet of water can be used.

Danger of burns, scalding and injury

- Do not touch the spouts during operation. Use the handles provided.
- Optionally, your X10 can be remotely operated using mobile devices. When preparing a product or initiating a maintenance programme, make sure that other people are not put at risk – for example, through contact with the spouts.
- Be careful to ensure that the dual spout is correctly installed and clean. Otherwise parts may come loose. There is a danger of parts being swallowed.

3 Preparing and using for the first time

Setting up the machine



- ▶ Choose a spot for your X10 which protects the machine against overheating. Ensure that the ventilation slots are not covered.
- ▶ Place the X10 on a horizontal surface that is not sensitive to water (minimum height of 80 cm).

Filling the bean container

The aroma preservation cover of the bean container is lockable (spanner supplied as standard).

CAUTION

Coffee beans which have been treated with additives (e.g. sugar), ground coffee or freeze-dried coffee will damage the grinder.

- ▶ Only use roasted, untreated coffee beans to fill the bean container.

- ▶ Remove the aroma preservation cover.
- ▶ Fill the bean container with coffee beans and close the aroma preservation cover.

Determining the water hardness

When you use the machine for the first time, you must set the water hardness. If you know the hardness of your water, go straight to the next section. If you do not know the water hardness, you can find this out first:

- ▶ Hold the Aquadur® test strip supplied under running water for one second. Shake off the water.
- ▶ Wait for about 1 minute.
- ▶ You will then be able to read the degree of water hardness from the discolouration of the Aquadur® test strip and the description on the packaging.

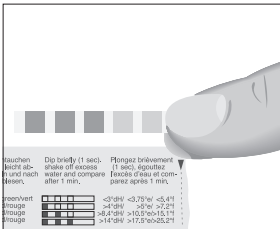

First-time use

⚠ WARNING

If the machine is operated with a defective mains cable, there is a danger of potentially fatal electric shock.

- ▶ Never use a machine which is damaged or has a defective mains cable.

CAUTION

Milk, sparkling mineral water or other liquids can damage the water tank or the machine.

- ▶ Only fill the water tank with fresh, cold water.

Precondition: The bean container has been filled.

- ▶ For machines with a **plug-in** mains cable: Connect the mains cable to the machine.
- ▶ Insert the mains plug into a power socket.
- ▶ Press the On/Off button  to switch the X10 on.

‘Sprachauswahl’ ‘Deutsch’

- ▶ Press the > or < button until the desired language is displayed, e.g. ‘English’.
- ▶ Press the ‘Save’ button.
- ▶ ‘Water hardness’

i Please refer to the section above for a description of how to determine the water hardness.

- ▶ Press the > or < button to change the setting for the water hardness.
- ▶ Press the ‘Save’ button.

‘Filter operation’ / ‘Insert filter’

- ▶ Place a receptacle under the dual spout.
- ▶ Remove the water tank and rinse it with cold water.
- ▶ Open the filter holder.

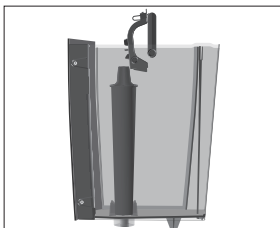

- ▶ Insert the CLARIS Pro Smart+ filter cartridge into the water tank, exerting slight pressure.
- ▶ Close the filter holder. It will click into place audibly.

3 Preparing and using for the first time

- ▶ Fill the water tank with fresh, cold water and reinsert the tank.

i The machine automatically detects that you have just inserted the filter cartridge.

‘Filter is being rinsed’, water flows directly into the drip tray.

‘System is filling’, water flows out of the dual spout.

‘Machine is heating’

‘Machine is rinsing’





‘Milk system is being rinsed’

The start screen is displayed. Your X10 is ready for use.

Managing your X10 – the JURA Cockpit



The **JURA Cockpit** allows you to manage your X10. Press the > button for **approx. 2 seconds** to enter the JURA Cockpit.

Symbol	Meaning
	‘Maintenance’ area (blue)
	‘Machine settings’ area (green)
	Product counter, day counter, maintenance counter
	Filter mode

Connecting milk

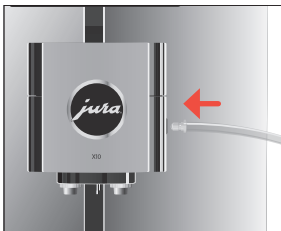

Your X10 creates fine, creamy, feather-light milk foam with a perfect consistency. The most important requirement for frothing milk is a milk temperature of 4–8 °C. We would therefore recommend using a milk cooler or a milk container.

- ▶ Connect the milk pipe to the dual spout.

i The milk system of your X10 has a connector **HP3** and an interchangeable milk spout **CX2**.

- ▶ Connect the other end of the milk pipe to a milk container or a milk cooler.

4 Preparation

Specialities:

Page ● ○ ○	'Espresso'	'Coffee'
	'Americano'	'Latte macchiato'
Page ○ ● ○	'Flat White'	'Cortado'
	'Lungo'	'Cappuccino'
Page ○ ○ ●	'Caffè latte'	'Hot water'
	'Milk'	'Milk foam'

Basic information about preparing drinks:

Aim	What to do
Change the coffee strength of a single product	Press the < or > button during grinding
Change the amount for a single product	Press the < or > button during preparation

i The longer you press the < and > buttons, the faster your setting changes.

Aim	What to do
Permanently save the amount for a single product	Press 'Save' straight after preparation
Change the amount, coffee strength and temperature for any given product	Press the button for a product for two seconds and configure the desired settings in 'Product settings'
Display more products	Press the > button to display the next product page
Prepare two speciality coffees	Press the preparation button twice within two seconds
Stop preparation	Press the 'X' button

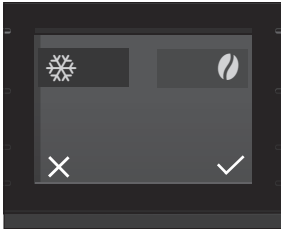

i Coffee tastes best served hot. A cold porcelain cup cools the beverage – and impairs the taste. We therefore recommend prewarming the cups. You can purchase a JURA cup warmer from your specialised dealer.

Preparation with preselection (Speciality Selection)



Press the  button to open the Speciality Selection.

Now choose the desired preselection for the product:



Speciality Selection	Meaning
 – ‘Cold Brew’ (all speciality coffees)	The product is prepared as a cold beverage.
 – ‘Extra Shot’ (for latte macchiato, flat white and cappuccino)	The product is prepared with two brewing operations, with half the amount of water – for a speciality coffee with a particularly intense taste.

i If you press and **hold** your preselection (for 2 seconds), the preselection will be active until you switch off your X10.

Espresso and coffee



Example: Coffee





- Place a cup under the dual spout.
 - Press the ‘Coffee’ button (on page   ).
- The preset amount of water for coffee flows into the cup.

Cold Brew

The ‘Cold Brew’ preselection  is used to prepare a cold speciality coffee.

Example: Flat white with ‘Cold Brew’ preselection

Precondition: Milk is connected to the dual spout.

- Fill the water tank with **cold** water.
- i** You can influence the brewing result: The colder the water in the water tank, the colder the brewed beverage will be.
- Add ice cubes to a glass according to your own preferences.
- Place the glass under the dual spout.
- Press the  button to display the **second page** of the start screen (  .
- Press the  button to open the Speciality Selection.
- i** If the ‘Cold Brew’ preselection is not shown, adjust the consistency of grind to **coarser** using the spanner.



- ▶ Press the ☼ button to activate the 'Cold Brew' preselection.
- ▶ Press the ✓ button.
- ▶ Press the 'Flat White' button.
The preset amounts of coffee and milk foam flow into the glass.

Latte macchiato, cappuccino and other speciality coffees with milk

Your X10 prepares the following speciality coffees with milk at the touch of a button:

- 'Latte macchiato'
- 'Flat White'
- 'Cortado'
- 'Cappuccino'
- 'Caffè latte'

Example: Latte macchiato

Precondition: Milk is connected to the dual spout.

- ▶ Place a glass under the dual spout.
 - ▶ Press the 'Latte macchiato' button (on page ●○○).
- The preset amounts of milk and milk foam flow into the glass.

i There is a short interval while the hot milk separates from the milk foam. This allows the typical layers of a latte macchiato to form.

The preset amount of water for espresso flows into the glass.

i **15 minutes** after preparation, the milk system is **automatically** rinsed. Therefore always place a receptacle under the dual spout after preparing milk.

To ensure that the milk system in the dual spout always works properly, you must clean it **daily** (see chapter 7 'Maintenance – Cleaning the milk system').

Americano and lungo

For the americano and lungo, the X10 blends the coffee with hot water using a special preparation method. This results in a full-bodied speciality coffee which is particularly easy to digest. You can change the amount of this additional water (see chapter 4 'Preparation – Adjusting the product settings').

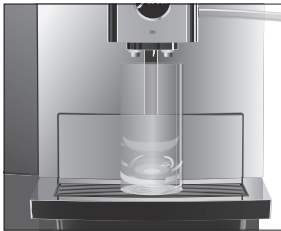

4 Preparation

Hot water

CAUTION

There is a danger of scalding from hot water splashes.

- ▶ Avoid direct contact with the skin.
 - ▶ Place a cup under the dual spout.
 - ▶ Press the 'Hot water' button (on page ).
- The preset amount of water flows into the cup.



Adjusting the grinder

You can adjust the grinder to suit the degree of roast of your coffee.

The consistency of grind is correct if the coffee flows regularly from the coffee spout. In addition a fine, thick crema forms.

You can set the consistency of grind using the spanner provided.

- ▶ Open the cover behind the bean container.
- ▶ Turn the grinder adjustment switch to the desired position.
- ▶ Close the cover.



Adjusting the product settings

Press a product button for **about two seconds** to view the list of settings:

- 'Product settings': Specify individual settings such as coffee strength, amount of water, etc.
- 'Reposition the product': Replace the products on the start screen with your favourites.

Permanent settings in programming mode always follow the same model.

Example: Proceed as follows to change the coffee strength for one coffee.

- ▶ Press the 'Coffee' button for **about two seconds**.
 - ▶ Press the 'Product settings' button.
- 'Coffee strength'

i Different settings will be available depending on the selected product: Press the ◀ or ▶ button to navigate the various settings.

- ▶ Press the > or < button to change the setting.
- ▶ Press the 'Save' button.
- ▶ Press the 'X' button to return to the start screen.

5 Daily operation

Switching the machine on and off



- ▶ Place a receptacle under the dual spout.
- ▶ Press the On/Off button .

'Machine is rinsing'

Your X10 is switched on or off.

- i** When the machine is switched off, the system is only rinsed if a speciality coffee has been prepared.
- i** If milk has been prepared before switching off, you will be prompted to carry out milk system cleaning ('Clean the milk system'). After 30 seconds the switch-off process continues automatically.

Filling the water tank

Daily maintenance of the machine and hygiene when handling milk, coffee and water are key to a perfect coffee result in the cup every time. You should therefore change the water **daily**.

CAUTION

Milk, sparkling mineral water or other liquids can damage the water tank or the machine.

- ▶ Only fill the water tank with fresh, cold water.

You can lock the water tank cover with the spanner provided.

- ▶ Open the water tank cover.
- ▶ Remove the water tank and rinse it with cold water.
- ▶ Fill the water tank with fresh, cold water and reinsert the tank.
- ▶ Close the water tank cover.

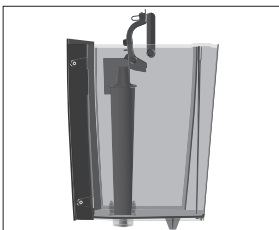

Maintenance actions

Optimal coffee quality depends on many factors. One important prerequisite is regular maintenance of your X10. Carry out the following steps:

Maintenance action	Daily	If necessary	Note
Empty the drip tray and coffee grounds container and rinse with warm water (The insert for the drip tray, including the drip tray itself, and the coffee grounds container are dishwasher-safe)	▪		Always empty the coffee grounds container when the machine is switched on. This is the only way of resetting the coffee grounds counter.
Clean the milk system (if heavily soiled, also dismantle and rinse it)	▪		See chapter 7 'Maintenance – Cleaning the milk system'. We recommend dismantling and rinsing the milk system once a week (see chapter 7 'Maintenance – Dismantling and rinsing the dual spout')
Rinse the milk pipe	▪		
Rinse the water tank	▪		
Wipe the surface of the machine with a clean, soft, damp cloth (e.g. microfibre cloth)	▪		
Changing milk pipe with connector HP3		approx. every 3 months	
Change the interchangeable milk spout CX2		approx. every 3 months	
Clean the inside of the water tank with a brush		▪	
Clean the top and bottom of the cup grille		▪	
Thoroughly clean the drip tray and coffee grounds container		▪	

i You will find more information about the maintenance of your X10 in the 'Maintenance' area  in the programme item 'Information'.

6 Machine settings

Press the > button for **approx. 2 seconds** to enter the JURA Cockpit. The following settings can be saved in 'Machine Settings' :

Programme item	Explanation
Page ●○○○	
'Switch off after'	Set the automatic switch-off time to save energy (switch-off after 15 minutes, 30 minutes or 1 – 9 hours after the last action on the machine)
'Water hardness'	Set the hardness of the water used (1 °dH to 30 °dH) to prevent limescale building up in your machine
'Product name'	Display product images with/without product names on the start screen
'Units'	Set the unit for the amount of water (ml or oz)
Page ○●○○	
'Choose language'	Set language
'Factory setting'	Reset your X10 to factory settings (the machine then switches off)
'Empty system'	Empty the system to protect the X10 from frost damage during transport (see chapter 10 'Transport and environmentally friendly disposal – Transport / Emptying the system')
'Version'	View software version
Page ○○●○	
'Lock/enable'	Blocking and releasing individual products
'Product settings'	Define whether the permanent product settings can be changed or not
'One-off settings'	Permit/do not permit one-off settings during preparation
Page ○○○●	
'Accessories' / 'QR code' (only shown when using the JURA Payment Connect)	(enabled, disabled) When you set the function to 'enabled' for the first time, a QR code appears. You can scan this to set up Pocket Pilot. Further information is available at jura.com/payment

7 Maintenance

Basic information about maintenance:

- Press the > button for **approx. 2 seconds** to enter the JURA Cockpit. You can manage the maintenance of your X10 in the ☸ section.
- If a maintenance programme is pending, a fourth page (red dot) will appear on the start screen.
- In the Cockpit of your X10, maintenance programmes that need to be carried out are shown in the form of messages with red backgrounds. Press the button that corresponds to the message to go straight to the maintenance programme. Maintenance programmes that are due imminently are indicated on your X10 by means of a bar display within the message.
- Carry out each maintenance programme when you are prompted to do so.

Rinsing the machine

You can start coffee system rinsing manually at any time.



Precondition: The start screen is displayed.

- Place a receptacle under the dual spout.
- Press the > button for **approx. 2 seconds** to enter the JURA Cockpit.
- Press the ☸ button.
- Press the **'Rinse the coffee system'** button to start the rinse operation.
'Milk system is being rinsed' / 'Machine is rinsing'
The operation stops automatically.

Automatic milk system rinsing

15 minutes after preparation, the milk system is **automatically** rinsed. Therefore always place a receptacle under the dual spout after preparing milk.

Inserting/changing the filter

Once the filter cartridge stops working (depending on the water hardness setting), the X10 will prompt you to change the filter.

- ❗ Your X10 no longer has to be descaled if you are using the CLARIS Pro Smart+ filter cartridge.
- ❗ CLARIS Pro Smart+ filter cartridges are available from specialised dealers.

Precondition: 'Filter' is displayed in the Cockpit if the filter's capacity has been exhausted.

- ▶ Remove and empty the water tank.
- ▶ Open the filter holder and remove the **old** CLARIS Pro Smart+ filter cartridge.
- ▶ Insert a **new** CLARIS Pro Smart+ filter cartridge into the water tank, exerting slight pressure.
- ▶ Close the filter holder. It will click into place audibly.
- ▶ Fill the water tank with fresh, cold water and reinsert the tank. The machine automatically detects that you have just inserted/changed the filter cartridge.
'Filter is being rinsed', water flows directly into the drip tray.

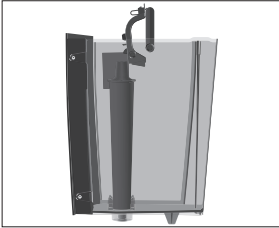

Cleaning the milk system

To ensure that the milk system in the dual spout always works properly, you must clean it **daily** when you have been preparing milk.

CAUTION

If the wrong cleaning agent is used, the machine could be damaged and/or traces could be left behind in the water.

- ▶ Use only original JURA maintenance products.

i JURA milk system cleaner is available from specialised dealers.

i Use the container supplied for milk system cleaning.

Precondition: 'Clean the milk system' is displayed in the Cockpit.

- ▶ Press the > button for **approx. 2 seconds** to enter the JURA Cockpit.
- ▶ Press the 'Clean the milk system' button.
'Clean the milk system'
- ▶ Press the 'Start' button.
'Add milk system cleaner'
- ▶ Remove the milk pipe from the milk container or milk cooler.
- ▶ Add 1 dosing unit of milk system cleaner to the rear part of the container.
- ▶ Place the container under the dual spout.

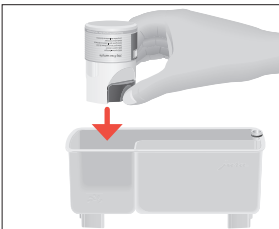

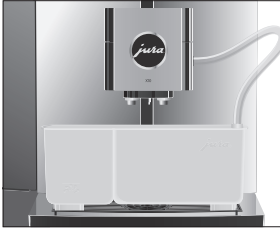

- ▶ Connect the milk pipe to the container.
 - ❗ To connect the milk pipe to the container correctly, the pipe must be fitted with a connector HP3.
- ▶ Press the 'Next' button.
'Cleaning milk system', the dual spout and the milk pipe are cleaned.
The operation stops automatically.

Dismantling and rinsing the dual spout

If insufficient foam is produced when the milk is frothed or milk sprays out of the dual spout, the spout may be dirty. If this happens, dismantle and rinse the dual spout.

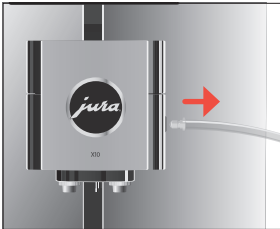

- ▶ Remove the milk pipe and rinse it thoroughly under running water.

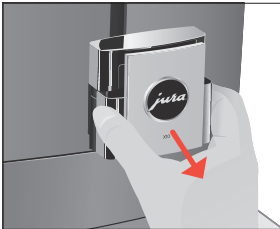

- ▶ Pull the cover of the dual spout forwards and off.



- ▶ Remove the milk system from the dual spout.

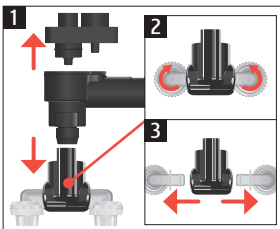

- ▶ Dismantle the milk system into its individual parts.
- ▶ Rinse all the parts under running water. If there are severely dried-on milk residues, firstly immerse the individual parts in a solution of 250 ml water and one dosing unit of JURA milk system cleaner. Then rinse the individual parts thoroughly.

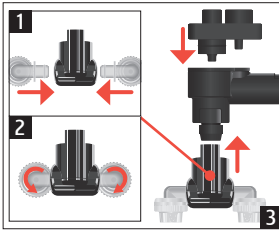

- ▶ Reassemble the milk system.

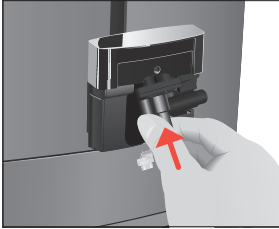

- ▶ Fit the assembled individual parts back in the dual spout and press it firmly.

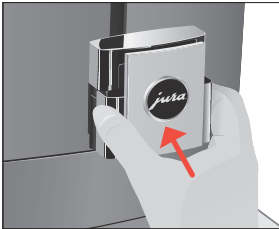

- ▶ Fit the cover of the dual spout.

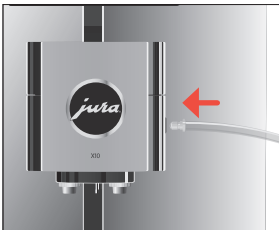

- ▶ Connect the milk pipe to the dual spout.

Cleaning the machine

After 180 preparations or 80 switch-on rinses, the X10 will prompt you to clean it.

CAUTION

If the wrong cleaning agent is used, the machine could be damaged and/or traces could be left behind in the water.

- ▶ Use only original JURA maintenance products.

- ❗ The cleaning programme lasts approximately 20 minutes.
- ❗ Do not interrupt the cleaning programme. The quality of cleaning will be impaired if you do so.
- ❗ JURA cleaning tablets are available from specialised dealers.

Precondition: 'Clean' is displayed in the Cockpit.

- ▶ Fill the water tank.
- ▶ Press the > button for **approx. 2 seconds** to enter the JURA Cockpit.
- ▶ Press the 'Clean' button.
- ▶ Press the 'Start' button.
'Empty grounds'
- ▶ Empty the drip tray and coffee grounds container and put them back into the machine.
'Clean'
- ▶ Place a receptacle under the dual spout.
- ▶ Press the 'Next' button.
'Machine is being cleaned', water flows out of the dual spout repeatedly.
The operation is interrupted, 'Add cleaning tablet'.
- ▶ Open the cover of the filler funnel for the cleaning tablet.

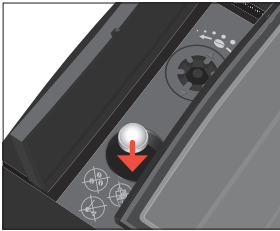

- ▶ Insert a JURA cleaning tablet into the filler funnel.
- ▶ Close the cover.
- ▶ Press the 'Next' button.
'Machine is being cleaned', water flows out of the dual spout repeatedly.
'Empty grounds'.
- ▶ Empty the drip tray and coffee grounds container and put them back into the machine.

Descaling the machine

The X10 builds up deposits of limescale over time and automatically prompts you to descale it when necessary (unless you are using a CLARIS filter cartridge Pro Smart⁺).

i If you are using a CLARIS Pro Smart⁺ filter cartridge, you will not be prompted to descale.

⚠ CAUTION

If the descaling agent comes into contact with the skin or eyes, this can cause irritation.

- ▶ Avoid contact with the skin or eyes.
- ▶ Rinse off the descaling agent with clean water. Should you get any descaling agent in your eye, see a doctor.

CAUTION

If the wrong descaling agent is used, the machine could be damaged and/or traces could be left behind in the water.

- ▶ Use only original JURA maintenance products.

CAUTION If the descaling operation is interrupted, there may be damage to the machine.

- ▶ Allow the descaling programme to run to the end.

CAUTION If the descaling agent comes into contact with sensitive surfaces (e.g. marble), damage cannot be ruled out.

- ▶ Clean up any splashes immediately.

- i** The descaling programme lasts approximately 40 minutes.
- i** JURA descaling tablets are available from specialised dealers.

Precondition: 'Descale' is displayed in the Cockpit.

- ▶ Press the > button for **approx. 2 seconds** to enter the JURA Cockpit.
- ▶ Press the 'Descale' button.
- ▶ Press the 'Start' button.
- 'Empty drip tray'
- ▶ Empty the drip tray and coffee grounds container and put them back into the machine.
- 'Agent in tank'
- ▶ Remove and empty the water tank.
- ▶ Completely dissolve 3 JURA descaling tablets in a receptacle holding 500 ml of water. This may take several minutes.
- ▶ Pour the solution into the **empty** water tank and insert it into the machine.

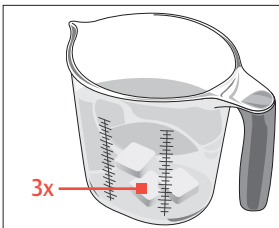

- ▶ Place a receptacle under the dual spout.
 - ▶ Press the 'Next' button.
 - 'Machine is being descaled', water will flow from the hot-water spout several times.
 - 'Empty drip tray'
 - ▶ Empty the drip tray and coffee grounds container and put them back into the machine.
 - 'Rinse the water tank' / 'Fill water tank'
 - ▶ Empty the receptacle and place it under the dual spout again.
 - ▶ Remove the water tank and rinse it thoroughly.
 - ▶ Fill the water tank with fresh, cold water and reinsert the tank.
 - ▶ Press the 'Next' button.
- The descaling operation is continued.
- 'Empty drip tray'

- ▶ Empty the drip tray and coffee grounds container and put them back into the machine.
- ▶ **i** If the descaling operation stops unexpectedly, rinse the water tank thoroughly.

Descaling the water tank

Limescale deposits may form in the water tank. To ensure correct function of the machine, descale the water tank from time to time.

- ▶ Remove the water tank.
- ▶ If you use a CLARIS Pro Smart+ filter cartridge, remove this.
- ▶ Completely fill the water tank and dissolve 3 JURA descaling tablets in it.
- ▶ Leave the water tank with the descaling solution for several hours (e.g. overnight).
- ▶ Empty the water tank and rinse it thoroughly.
- ▶ If you use a CLARIS Pro Smart+ filter cartridge, insert this again.
- ▶ Fill the water tank with fresh, cold water and reinsert the tank.

Cleaning the bean container

Coffee beans may be covered with a slight oil film which remains on the walls of the bean container. These traces may negatively affect the coffee result. For this reason clean the bean container from time to time.

Precondition: 'Fill bean container' is displayed.

- ▶ Switch the machine off with the On/Off button .
- ▶ Remove the aroma preservation cover.
- ▶ Clean the bean container with a soft, dry cloth.
- ▶ Fill the bean container with coffee beans and close the aroma preservation cover.

8 Display messages

Messages on the start screen

Message	Cause/Result	Action
'Fill water tank'	The water tank is empty. You cannot prepare any products.	▶ Fill the water tank (see chapter 5 'Daily operation – Filling the water tank').
'Empty grounds' / 'Empty drip tray'	The coffee grounds container is full. / The drip tray is full. You cannot prepare any products.	▶ Empty the coffee grounds container and the drip tray (see chapter 5 'Daily operation – Maintenance actions').
'Drip tray not fitted'	The drip tray is not inserted correctly or is not inserted at all. You cannot prepare any products.	▶ Fit the drip tray.
'Fill bean container'	The bean container is empty. You cannot prepare any speciality coffees, but you can prepare hot water and milk.	▶ Fill the bean container (see chapter 3 'Preparing and using for the first time – Filling the bean container').
'Too hot'	The system is too hot to start a maintenance programme.	▶ Wait for several minutes until the system has cooled or prepare a speciality coffee or hot water.

Messages in the Cockpit

Message	Cause/Result	Action
The filter symbol  lights up red. 'Filter'	The filter cartridge no longer works.	▶ Replace the CLARIS Pro Smart ⁺ filter cartridge (see chapter 7 'Maintenance – Inserting/changing the filter').
'Clean'	The X10 is prompting you to clean it.	▶ Perform cleaning (see chapter 7 'Maintenance – Cleaning the machine').
'Descale'	The X10 is prompting you to descale it.	▶ Perform descaling (see chapter 7 'Maintenance – Descaling the machine').
'Clean the milk system'	The X10 prompts you to clean the milk system.	▶ Perform milk system cleaning (see chapter 7 'Maintenance – Cleaning the milk system').

9 Troubleshooting

Problem	Cause/Result	Action
Insufficient foam is produced when the milk is frothed or milk sprays from the dual spout.	The dual spout is dirty.	<ul style="list-style-type: none"> ▶ Clean the milk system in the dual spout (see chapter 7 'Maintenance – Cleaning the milk system'). Dismantle and rinse the dual spout (see chapter 7 'Maintenance – Dismantling and rinsing the dual spout').
Coffee only comes out in drips when it is being prepared.	The coffee is ground too finely and obstructs the system.	<ul style="list-style-type: none"> ▶ Set the grinder to a coarser setting (see chapter 4 'Preparation – Adjusting the grinder').
	The water hardness may not have been correctly set.	<ul style="list-style-type: none"> ▶ Perform descaling (see chapter 7 'Maintenance – Descaling the machine').
There is dry ground coffee behind the coffee grounds container.	The beans used are resulting in an above-average volume of ground coffee.	<ul style="list-style-type: none"> ▶ Reduce the coffee strength or choose a finer grinder setting (see chapter 4 'Preparation – Adjusting the product settings').
Little or no steam comes out of the dual spout. The pump is very quiet.	The connector of the milk system in the dual spout may be blocked by milk residues or limescale fragments loosened during descaling.	<ul style="list-style-type: none"> ▶ Pull the cover of the dual spout forwards and off. ▶ Remove the milk system from the dual spout. ▶ Unscrew the black connector using the hexagonal hole on the spanner. ▶ Clean the connector thoroughly. ▶ Screw the connector back on by hand. ▶ Carefully tighten it using the hexagonal hole on the spanner, turning by no more than a quarter of a rotation.
Grinder is making a very loud noise.	There are foreign objects in the grinder.	<ul style="list-style-type: none"> ▶ Contact customer support in your country (see chapter 13 'JURA contact details / Legal information').
'ERROR 2' or 'ERROR 5' is displayed.	If the machine has been exposed to the cold for a long period of time, heating may be disabled for safety reasons.	<ul style="list-style-type: none"> ▶ Warm the machine at room temperature.

Problem	Cause/Result	Action
Other 'ERROR' messages are displayed.	–	► Contact customer support in your country (see chapter 13 'JURA contact details / Legal information').

- i** If you were unable to solve the problem, contact customer support in your country (see chapter 13 'JURA contact details / Legal information').

10 Transport and environmentally friendly disposal



Transport / Emptying the system

Keep the packaging for your X10. It should be used to protect the machine during transport.

In order to protect the X10 from frost during transport, the system must be emptied.



Precondition: The start screen is displayed.

- ▶ Place a receptacle under the dual spout.
- ▶ Press the > button for **approx. 2 seconds** to enter the JURA Cockpit.
- ▶ Press the  button.
- ▶ Press the > button to go to page .
- ▶ Press the 'Empty system' button.
- ▶ Remove and empty the water tank.

'System is emptying'

Steam will continue to be discharged from the dual spout until the system is empty. Your X10 is switched off.

Disposal

Please dispose of old machines in an environmentally neutral way.



Old machines contain valuable, recyclable materials which should be recycled. Please therefore dispose of old machines via suitable collection systems.

11 Technical data

Voltage	220–240 V ~, 50 Hz
Power	1450 W
Ambient conditions	Humidity max. 80 % Ambient temperature 10 – 35 °C
Sound pressure level	LP < 70 dB (A)
Conformity mark	CE UK
Pump pressure	static, max. 15 bar
Holding capacity of water tank (without filter)	5 l
Holding capacity of bean container	500 g (can be increased to 1000 g)
Holding capacity of coffee grounds container	max. 40 portions
Milk system with connector	HP3
Interchangeable milk spout	CX2
Cable length	approx. 1.2 m
Weight	approx. 14 kg
Dimensions (W × H × D)	37.3 × 47 × 46.1 cm
CLARIS filter cartridge Pro Smart* (RFID technology)	Frequency band 13.56 MHz Max. transmission power < 1 mW
JURA Wi-Fi Connect (Wi-Fi connection)	Frequency band 2.4 GHz Max. transmission power < 100 mW
JURA type	777

Information for testers (repeat test in accordance with DIN VDE 0701-0702): The central grounding point (CGP) is located on the back of the machine, right next to the mains cable's connection point.

12 Index

A

- Addresses 36
- Adjusting the product settings 16
- Americano 15
- Aroma preservation cover
 - Bean container with aroma preservation cover 5

B

- Bean container
 - Bean container with aroma preservation cover 5
 - Cleaning 26
 - Filling 10
- Bus bar
 - Technical data 31
- Button
 - On/Off button 5

C

- Caffè latte 15
- Cappuccino 15
- Central grounding point 31
- Children 7
- CLARIS Pro Smart filter cartridge
 - Changing 20
 - Inserting 20
- Cleaning
 - Bean container 26
 - Machine 23
- Cockpit 12, 19, 20
- Coffee 14
- Coffee grounds container 5
- Cold Brew 14
- Consistency of grind
 - Adjusting the grinder 16
 - Grinder adjustment wheel 5
- Contact details 36
- Cover 5
 - Water tank 5
- Cup grille 5
- Customer support 36

D

- Damage
 - Preventing damage 8
 - What to do in the event of damage 7
- Declaration of Conformity 36
- Descaling
 - Machine 24
 - Water tank 26
- Display 5
 - Cockpit 12
- Display messages 27
- Disposal 30
- Drip tray 5
 - Insert 5
- Dual spout
 - Dismantling and cleaning 22
 - Height-adjustable dual spout 5

E

- Emptying the system 30
- Errors
 - Troubleshooting 28
- Espresso 14
- EU Declaration of Conformity 36

F

- Filler funnel
 - Filler funnel for cleaning tablet 5
- Filling
 - Bean container 10
 - Water tank 17
- Filter
 - Changing 20
 - Inserting 20
- First-time use 11
- Flat white 15

G

- Grinder adjustment wheel 5
- Grounding point 31

H

- Hotline 36
- Hot water 16

- I**
- Insert for drip tray 5
 - Interchangeable milk spout 31
- J**
- JURA
 - Contact details 36
- L**
- Latte macchiato 15
 - Lungo 15
- M**
- Macchiato 15
 - Machine
 - Cleaning 23
 - Descaling 24
 - Rinsing 20
 - Setting up 10
 - Machine settings 19
 - Mains cable 5
 - Maintenance 20
 - Maintenance actions 18
 - Messages, display 27
 - Milk
 - Connecting milk 12
 - Milk system 31
 - Clean 21
 - Milk system rinsing 20
- P**
- Preparation 13, 15
 - Americano 15
 - Caffè latte 15
 - Cappuccino 15
 - Coffee 14
 - Cold Brew 14
 - Espresso 14
 - Flat white 15
 - Hot water 16
 - Latte macchiato 15
 - Lungo 15
 - Macchiato 15
 - Speciality Selection 14
 - Problems
 - Troubleshooting 28
 - Product settings
 - Adjusting 16
 - Proper use 6
- R**
- RFID 31
 - Rinsing
 - Machine 20
- S**
- Safety information 6
 - Setting up
 - Setting up the machine 10
 - Speciality Selection
 - Extra Shot 14
 - Ground coffee 14
 - Spout
 - Height-adjustable dual spout 5
 - Switching off 17
 - Switching on 17
 - Symbol description 6
- T**
- Technical data 31
 - Interchangeable milk spout 31
 - Milk system 31
 - Tel 36
 - Transport 30
 - Troubleshooting 28
- U**
- Use, first time 11
 - Users 6
- W**
- Water hardness
 - Determining the water hardness 10
 - Water tank 5
 - Descaling 26
 - Filling 17
 - Wi-Fi 31
 - Wireless connection 11, 20, 31

13 JURA contact details / Legal information

Your JURA service partner



JURA Elektroapparate AG
 Kaffeeweltstrasse 10
 CH-4626 Niederbuchsiten
 Tel. +41 (0)62 38 98 233

- i** You can find additional contact details for your country at **jura.com**.
- i** If you need assistance with using your machine, you can find this at **jura.com/service**.
- i** Your opinion is important to us! Use the contact details at **jura.com**.

Directives The machine complies with the following directives:

- 2006/42/EC – Machinery Directive
- 2014/30/EU – Electromagnetic Compatibility
- 2009/125/EC – Ecodesign Directive
- 2011/65/EU – RoHS Directive
- 2014/53/EU – Wireless Voltage Directive

A detailed EU Declaration of Conformity for your X10 can be found at **jura.com/conformity**.

Technical changes We reserve the right to make technical changes. The diagrams used in these instructions for use are for illustration purposes only and do not represent the original colours of the machine. Some details of your X10 may vary.